

la Pavoni spa - Via Privata Gorizia, 7 - 20098 San Giuliano Milanese (MI) - Italia - Telefono 02-90341644 - Telefax 02-90241541

◆ Grafiche Moratti s.p.a. - Segrate (MI)

Cod. 383003 - Rev. 03 - Maggio 1997

ISTRUZIONI D'USO

PROFESSIONAL - EUROPICCOLA

Dal 1905 macchine per caffè

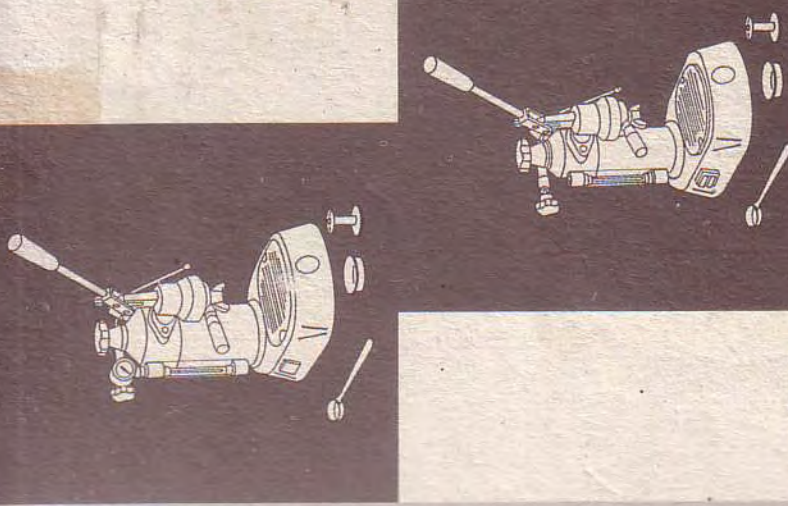

la Pavoni

la Pavoni

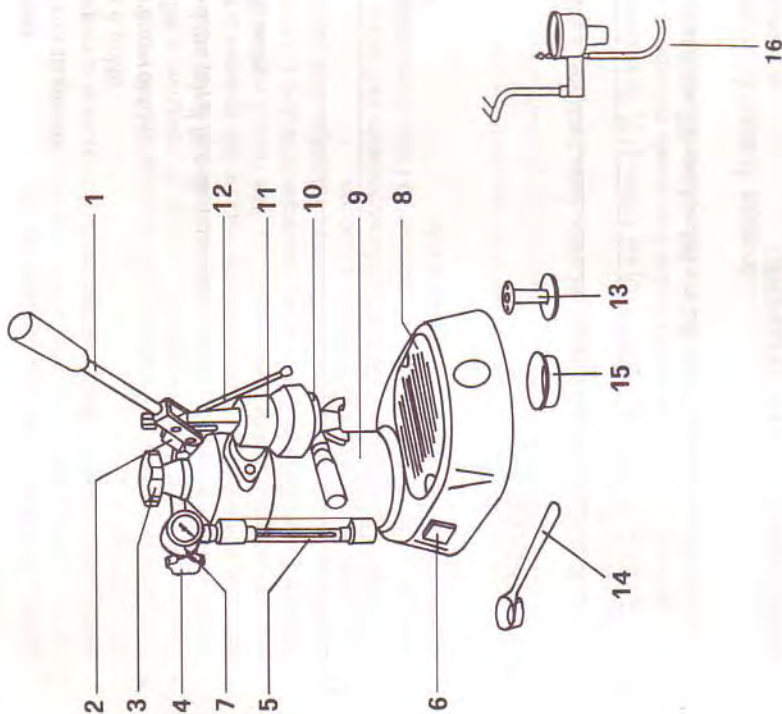

- 1 Lever
- 2 Safety valve
- 3 Boiler cap
- 4 Steam tap knob
- 5 Sight glass
- 6 On-off switch
- 7 Pressure gauge
- 8 Drip tray grill
- 9 Boiler
- 10 Filter holder
- 11 Group
- 12 Steam tube
- 13 Press
- 14 Measuring spoon for one coffee
- 15 Filter
- 16 Cappuccino Automatic

ESPRESSO COFFEE MACHINE PROFESSIONAL MODEL

In order to obtain a good espresso coffee, it is important to use a top quality coffee, correctly ground. If grind is correct, the coffee should come out drop by drop when the machine is under pressure and the lever (1) is held in the upright position.

HOW TO USE THE MACHINE

- Unscrew the boiler cap (3) anticlockwise, draw. A.

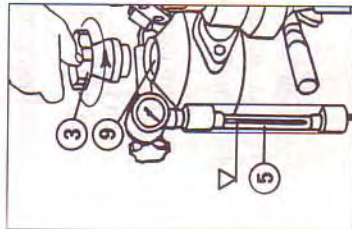

DRAW A

- Push the lever (1) completely down, draw. C.

- Fill the boiler (9) with water - water quantity depends the number of coffees required (capacity equivalent to 16 cups of espresso). However, water should not go above the top of the sight glass (5), draw. A, since space in the boiler is required for steam.

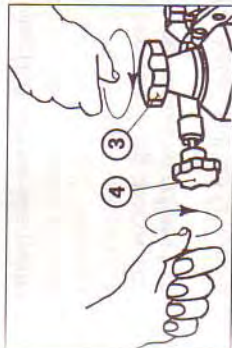

DRAW B

- Screw the boiler cap (3) clockwise and check that both cap and steam tap knob are shut (turn clockwise) draw. B.

- Insert the plug into a socket providing the correct voltage (see label under the machine base), draw. C.

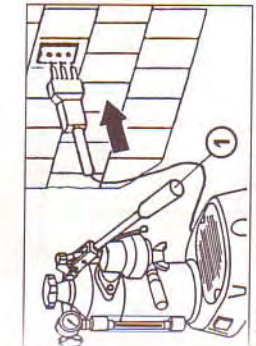

DRAW C

- When you use the coffee machine for the first time, we recommend you put in the boiler (9) some water and two spoons of bicarbonate of soda. When the machine reaches pressure, put a container under the group and raise the lever (1) slowly in order to empty completely the water contained in the boiler. Machine is up to pressure when the pressure gauge needle goes into the green zone.

SETTING UP THE MACHINE FOR USE

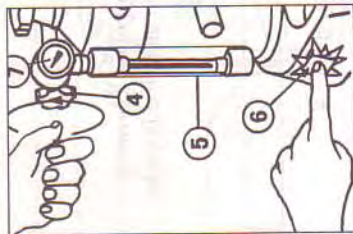

DRAW D

- Check the water level in the boiler: it should never be below the bottom of the sight glass (5).
- Press the switch (6) to turn on the internal warning lamp, indicating that the machine is power supplied, draw D.
- When the pressure gauge pointer (7) reaches the green area, open the steam knob (4) slowly to let out the "false pressure" due to the air in the boiler. Close it again clockwise and wait for the pressure gauge pointer to reach the green area again. The pressure will thereafter be automatically adjusted and maintained.

The machine is now ready to make coffee and deliver steam.

- When preparing for the first coffee, when the machine is up to pressure, it is recommended to lift the lever (1) up to half of its stroke and then to lower it; this operation should be repeated 2-3 times to allow the group to heat and filter holder to heat up, draw E.
- If the machine is left without water, the thermal fuse link on the heating element will cut off the machine to protect the element. If this happens, the fuse link must be replaced.

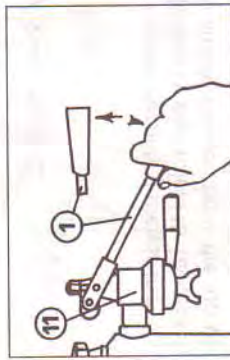

DRAW E

MAKING COFFEE

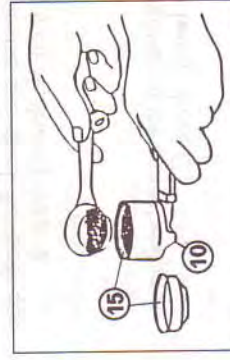

DRAW F

- Put the one - or two - coffee filter (15) into the filterholder (10), draw F.
- Fill the filter (15) with one or two measuring spoons of ground coffee, depending on the number of coffees to be prepared (draw F). Attention: if overfilled, the filter holder will not fit readily into the group.
- Press down coffee using the press (13) and clean filter edges of coffee, draw G.

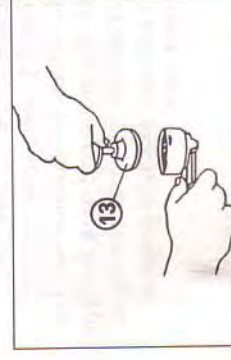

DRAW G

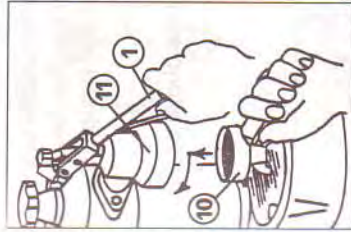

DRAW H

- Put the filter holder into the group (11) taking care to hold the machine still by holding the lever handle (1) with the other hand; turn from right to left to lock in the filter holder, draw H.
- Raise the lever (1) keeping your left hand on the filterholder handle to hold it firmly in place. Leave it in the upright position for a few seconds. Allow the first drops of coffee to appear and lower the lever. If this requires too much effort coffee is too fine or it has been pressed down too firmly. If the coffee appears weak or flows too freely the opposite will be true. A good coffee will have a typical creamy surface.
- In order to obtain an even coffee delivery, pressure on the lever should be proportional to resistance faced by the lever during the delivery.
- After making coffee, leave lever down (idle position) so that water cannot come out from the boiler and switch the machine off.

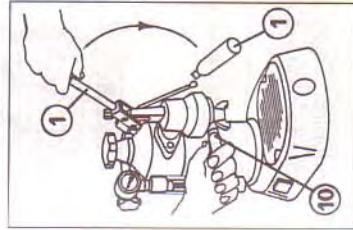

DRAW I

Warning: after making coffee, do not take out the filter holder immediately, but wait a few seconds; this allows any of residual pressure above the filter holder to release itself. It avoids the coffee grounds being blown out of the filter on removal of the filter holder. Never remove filter holder unless the lever is in the fully down position.
The replacement of the traditional steam tube (12) with the Cappuccino Automatic (16) (optional on black painted base models), should be carried out before using the machine, if you wish to use it.

Do this as follows:

- Make sure that the steam tap knob (4) is closed as per drawing B.
- Turn the steam pipe (12) clockwise, until it stops and take it off its seat, pulling it outwards (see draw. N).

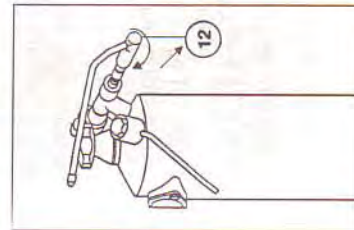

DRAW N

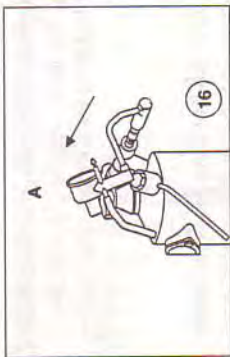

DRAW O

Push the Cappuccino Automatic (16) onto its suitable seat pushing it leftwards (see drawing O), then turn the device with Cappuccino Automatic (16) anti-clockwise until it stops (see draw. P).

To remount the steam pipe (12) just repeat the above operation in the reverse.

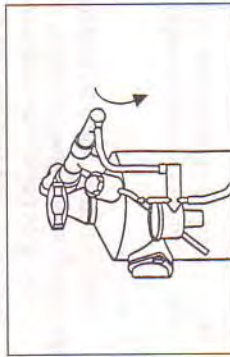

DRAW P

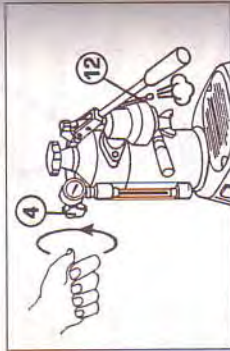

DRAW L

STEAM DELIVERY

- After checking that there is water in the boiler and after carrying out all the previous operations to put the machine under pressure, make sure that the lever is in the bottom (idle position) and keep it in this position.
- Before heating any liquid let some steam escape from tube (12) by opening the steam tap knob (4) anticlockwise to remove any water from the tube. Then, open the tap further to reach a good steam pressure, draw L.
- In order to obtain a large quantity of steam, water inside the boiler should be about half way up the sight glass (5).

CAPPUCCINO MAKING

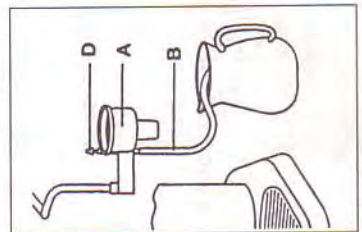

DRAW Q

After carrying out the operations in the paragraph "STEAM BREWING", insert the suction pipe (B) in the milk container, placed beside the machine (drawing Q).

Put the cup after making the coffee under the Cappuccino Automatic spout and open the steam tap handle (4) anti-clockwise, now, warm, frothy milk is dispensed. By turning the gudgeon pin (D - drawing Q and R), it is possible to regulate the milk froth; pulling it upwards, a more bubbly volume is achieved.

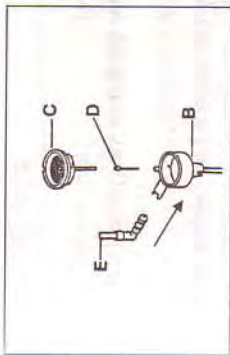

DRAW R

To stop dispensing, close the steam tap knob (4), clockwise. After each use, Cappuccino Automatic needs to be cleaned to remove any milk residues.

- Put a glass of water next to the machine, into which you should place the suction pipe (8).
- Follow the normal Cappuccino making operation, letting dirty water flow into a suitable container.

Cappuccino can also be made using the steam jet. Use a jug half full with milk and place the steam jet just below the milk surface. Gradually open the steam jet. As the froth develops, move the jug up and down, continuing to open the steam jet until a good froth is obtained. Frothed milk should be 2 or 3 times the starting depth. Do not steam too long, if so, milk will boil and froth will collapse. Close the steam jet knob, then, to obtain cappuccino, add the frothed milk to the coffee you had prepared before. At the end of all operation, re-open steam jet to prevent milk congealing in the tip of the jet. Close steam jet knob. If the jet becomes blocked, clean with a needle.

CAPPUCCINO AUTOMATIC MAINTENANCE (see draw. R)

In addition to immediate cleaning after use, it is necessary to occasionally give the Cappuccino Automatic a more careful cleaning.

Take Cappuccino Automatic off its seat (E), take the cap (C), the suction pipe (B) and the gudgeon-pin (D) out and wash them all under running water (draw. R). At the end of this operations, reassemble the parties starting from the last.

WARNING

- Install the machine on a steady and dry base.
- Always check water level in the sight glass (5); lack of water when machine is under operation may cause the heating element to burn out. However the machine is equipped with a thermal fuse link for the element.
- When the machine is switched on, the water heats and produces pressurized steam inside the boiler. For safety reasons, keep the machine off children's reach.
- Avoid touching the boiler (9) and the group (11) when the machine is hot.
- Never open the boiler cap (3) when the machine is under pressure, to unscrew the cap in order to refill the boiler, press switch (5) to turn the machine off. Slowly open the steam tap knob (2) anticlockwise and let the steam completely escape from tube (12). If steam does not flow out freely, remove filter holder (10) and slowly lift up the lever (1). In this way steam and water inside the boiler will come out through the group. In both cases, it is recommended to use a container to collect steam and water.
- By switching the machine off, during the water in the boiler cooling, it may happen that the lever raises up by itself; this is due to the depression inside the boiler.

MAINTENANCE

- Before any cleaning operation, disconnect the plug from socket.
- Regularly clean the filter holder (10) and the filter (15), the filter basket in the group (11) and the drip basin (8) as well as the steam tube end (12).
- Never immerse the machine in water.
- Keep your machine clean by wiping it with a damp cloth after use once it has cooled down.

TROUBLESHOOTING GUIDE

- The machine does not operate and switch warning lamp does not light on:
 - 1) mains failure
 - 2) power supply cord is not properly connected.
- Switch warning lamp is on, but water is not heated: thermal fuse link needs replacement; take off the cap of the underbase and push the red button to restore the thermal fuse link.
- Machine does not deliver steam:
 - clean holes on steam tube (12) end using a needle

During the delivery

- Coffee is not delivered:
 - 1) no water in the boiler
 - 2) coffee grind is too fine
 - 3) too much coffee in filter, or a combination of 2+3
- Coffee flows out too quickly:
 - 1) coffee grind is too coarse
 - 2) coffee quantity is not sufficient
- Coffee comes out drop by drop:
 - 1) coffee grind is too fine
 - 2) too much coffee in filter
- Coffee comes out from side of filter holder:
 - 1) filterholder is not correctly inserted
 - 2) too much coffee in filter
 - 3) filterholder edge is not clean
 - 4) group filter gasket is worn out
- No cream on coffee:
 - 1) coffee blend is not suitable
 - 2) grind is not correct
 - 3) coffee quantity is not sufficient

ACCESSORIES

Drip tray with grill
 One - and two - coffee filters
 Measuring spoon for one coffee
 Press
 Cappuccino Automatic

TECHNICAL DATA

Model Professional

Sizes: width cm 20 - height cm 32 - depth cm 29

Weight: 5,5 kgs

Boiler capacity: equivalent to 16 cups of espresso

Steam delivery: 15 mins. (continuous)

Power supply cord: length cm 150

Pressure inside boiler: 0,7 - 0,8 atm.

Heating mean time: 5 mins.

Power supply: 230 Volt, 50 Hz for Professional/A, or 120 V 60 Hz



Heating element: 1000 Watt

Thermal fuse link for the heating element

Pressurestat keeping constant pressure in boiler.

Available in the following models:

- normal (with painted base)
- lusso (all chrome)
- copper and brass
- gold plated.

The underbase is fixed to the machine by means of a special screw called "Torx", to avoid any tampering with the electrical parts; therefore, for whatever intervention or possible replacement of the power supply cord, please apply to the authorized after sale services.